

GASO.LINE

Panzerjäger Sd.Kfz.251/22

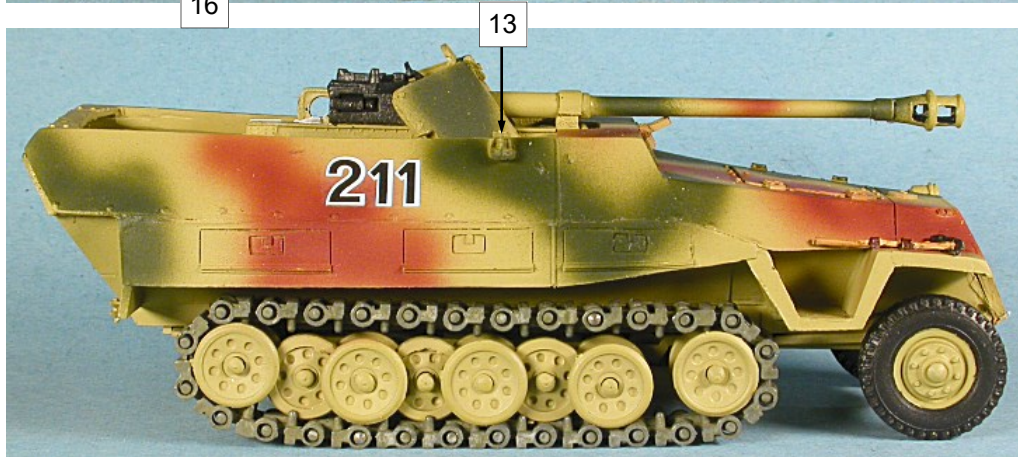

CARACTERISTIQUES TECHNIQUES

L'ultime version du célèbre half-track allemand Sdkfz. 251, le modèle 22, dont l'armement principal, le canon anti-char PaK 40 de 75 mm. avec 22 obus était complété par une mitrailleuse MG 42. Cette transformation intervint au dernier stade du deuxième conflit mondial soit fin 1944 début 1945. L'affût du canon était boulonné sur une platine soudée à deux poutrelles métalliques elles même soudées le toit de la cabine du conducteur et au plancher de la caisse. Ce véhicule faisait en 1945 partie des unités de chasseurs de chars conçues comme dernier recours face au déferlement des armées alliées.

TECHNICAL CHARACTERISTICS

The ultimate development of the famous German Sdkfz 251 half-track: the 22 type which main weapon was the anti-tank 75 mm PaK 40 with 22 rounds along with a MG 42 machine-gun. This evolution intervened at the very last stage of WWII i.e. late 1944 early 1945. The gun mount was bolted onto a plate welded on two I struts which were welded to the roof of driver's compartment and the hull floor. This vehicle was part in 1945 of the anti-tank units set up as a last ditch measure against the overwhelming power of the Allies.



Ce modèle est fabriqué par **Quarter Kit Modèle Shop**
5, passage du charolais 75012 Paris France
Tél./Phone: (33) 01.44.75.01.16 Fax: (33) 01.44.75.01.61
E-mail: info@quarter-kit.com Web site: www.quarter-kit.com

**Nomenclature Panzerjäger Sd.Kfz.251/22
GAS50864K**

N°	Désignation	Quantité
1	Caisse Modifiée	1
2	Dessus de caisse	1
3	Embase canon	1
4	Tableau de bord	1
5	Banquette	1
6	Dossier banquette	1
7	Suspension avant	1
8	Chaise de route canon	1
9	MG42	1
10	Sièges	2
11	Crochet de remorquage arrière	1
12	Volant	1
13	Plot d'antenne	1
14	Crochet de remorquage avant gauche	1
15	Crochet de remorquage avant droit	1
16	Chapeau pot d'échappement	1
17	Phare	1
18	Support arrière MG42	1
19	Pioche	1
20	Hache	1
21	Affût canon	1
22	Bouclier canon	1
23	Visueur	1
24	Volant	1
25	Blindage bouclier	1
26	Coffre	1
27	Frein de bouche	1
28	Étrier canon	1
29	Bague canon	1
30	Rail affût canon	1
31	Axe étrier canon	1
32	Canon 75 mm	1
33	Tige laiton Ø 1 x 25 mm	1

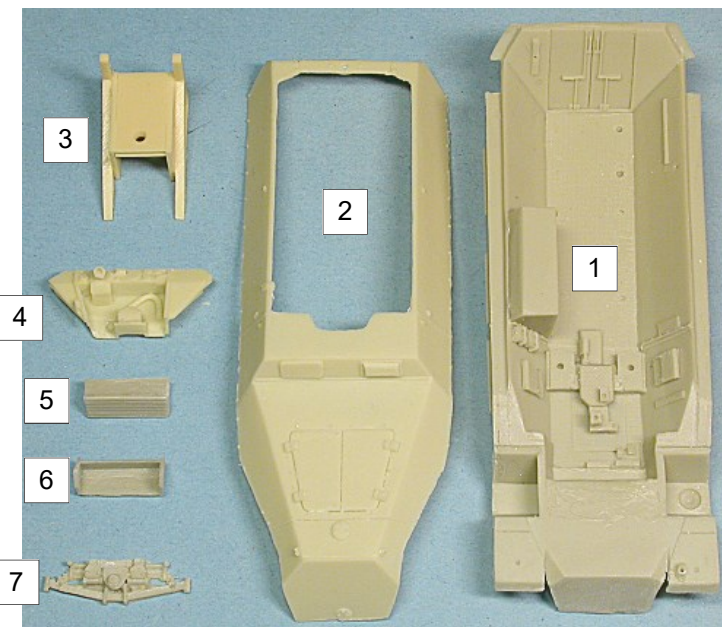
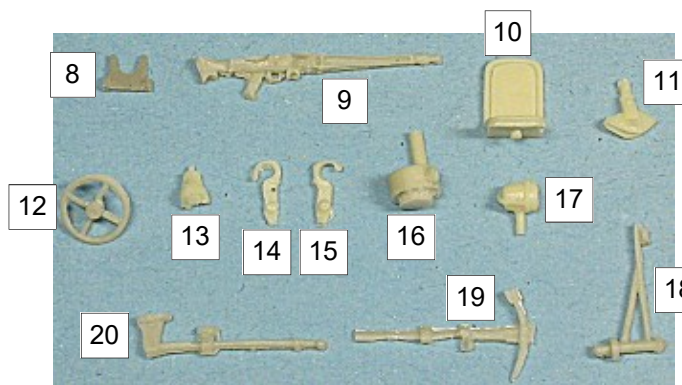

Preparation of the soldo model
Préparation du modèle Solido

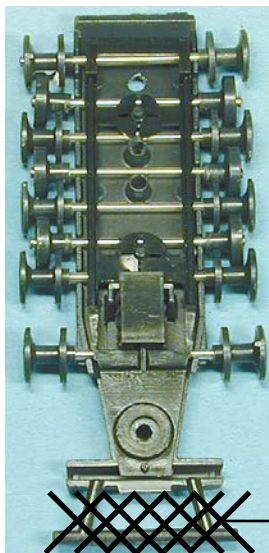

To suppress
Supprimer

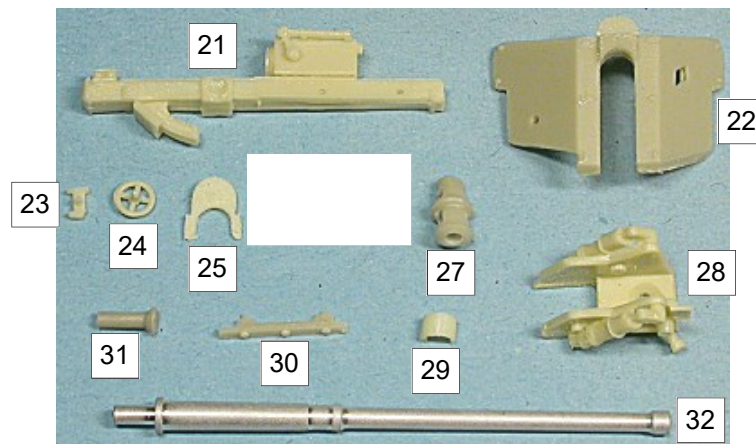

Si vous avez des pièces défectueuses ou manquantes, n'hésitez pas à nous contacter.
If you have faulty or missing parts, don't hesitate to contact us.

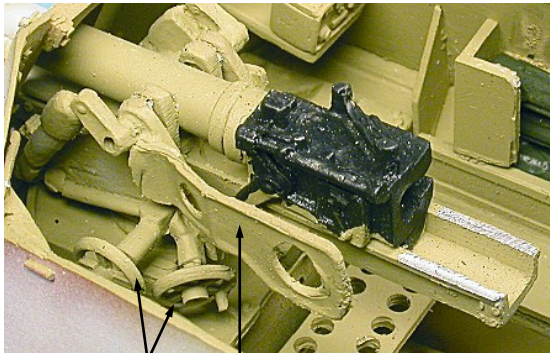

24

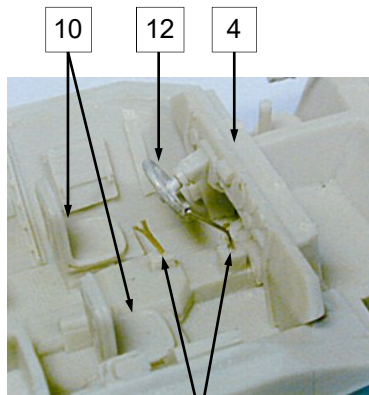

10

12

4

Épingle / Pin

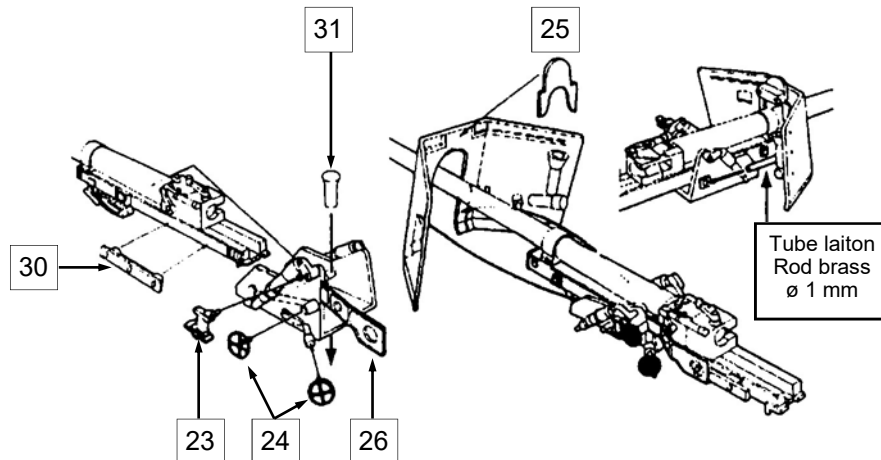

31

25

30

23

24

26

Tube laiton
Rod brass
ø 1 mm



6

26

211



11



15

14

7



8

135

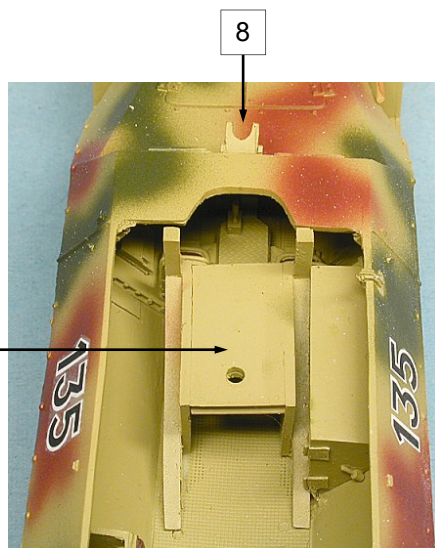

8

3

135

135



19

17

20

18

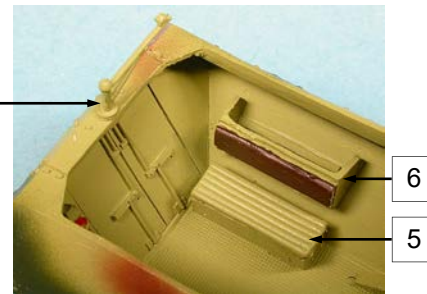

6

5