

# GASO.LINE

## Char dépanneur Leclerc DCL

Nomenclature Leclerc DCL GAS87009K		
N°	Designation	Qty
1	Hull / Caisse	1
2	Crane / Grue	1
3	Shovel / Pelle	1
4	Crane base / Base grue	1
5	Honk / Sirène	1
6	Smoke pot launcher multiple Lance grenades multiple	1
7	Hoist / Poulie	1
8	Tracks R + L / Chenilles	1 + 1
9	Skirt R + L / Jupes	1 + 1
10	Machin gun / Mitrailleuse	1
11	Cupola / Tourelle	1
12	Smoke pot launcher solo Lance grenades seul	3
13	Smoke pot launcher double Lance grenades duo	1
14	Generator / Générateur	1
15	Tools / Outils	1
16	Pulley / Poulie	1
17	Box / Coffres	1 + 1
18	Tow bar / Barre remorquage	1
19	Exhaust outlet Sortie échappement	1
20	Tige laiton Ø 0.5 x 10 mm	1

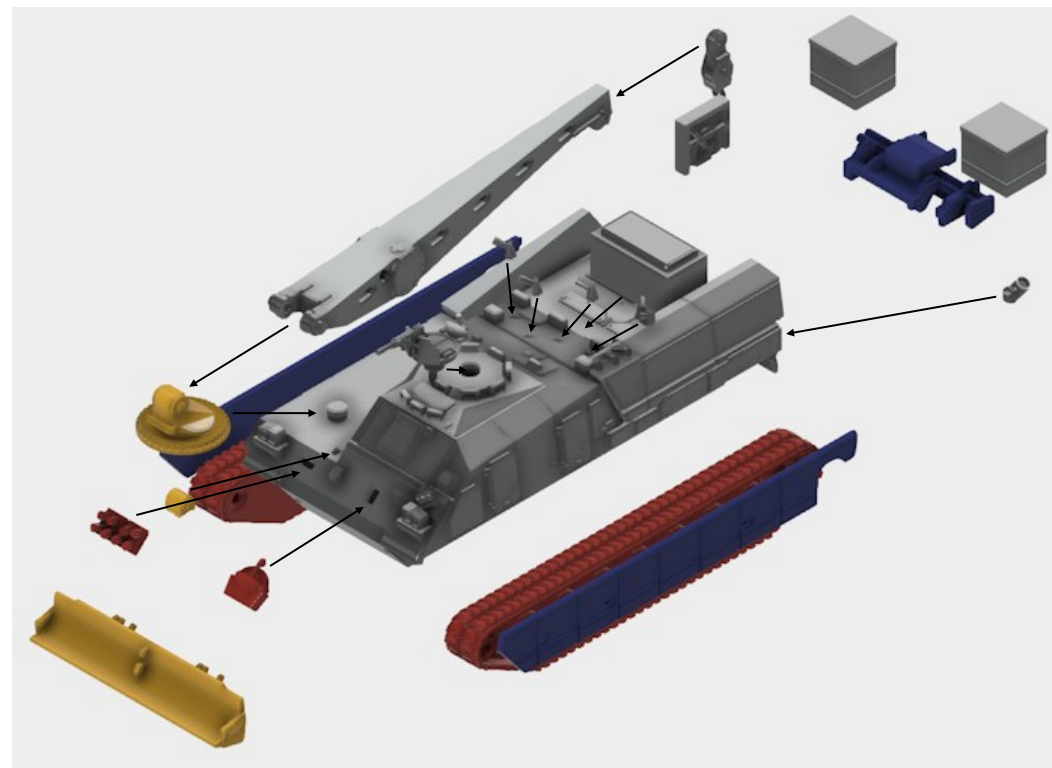
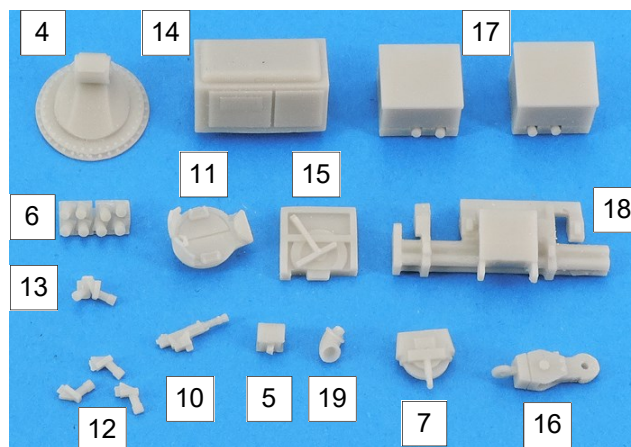
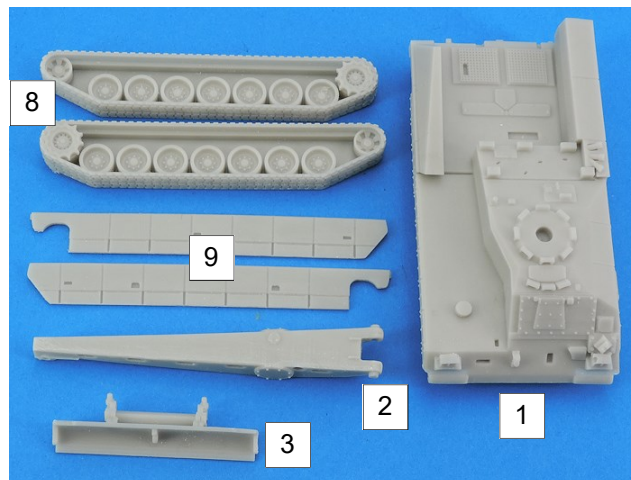

Ce modèle est fabriqué par **Gaso.line**  
 10, passage du charolais 75012 Paris France  
 Tél./Phone: (33) 01.44.75.01.61  
 E-mail: info@quarter-kit.com Web site: www.promodels.eu

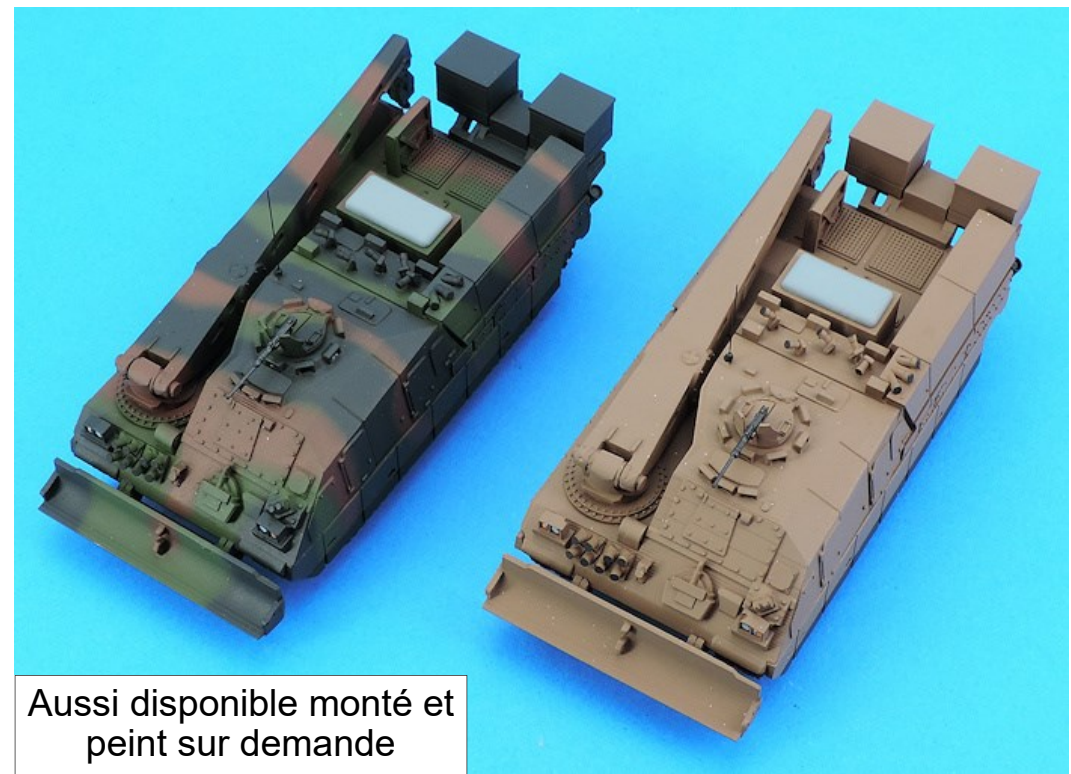
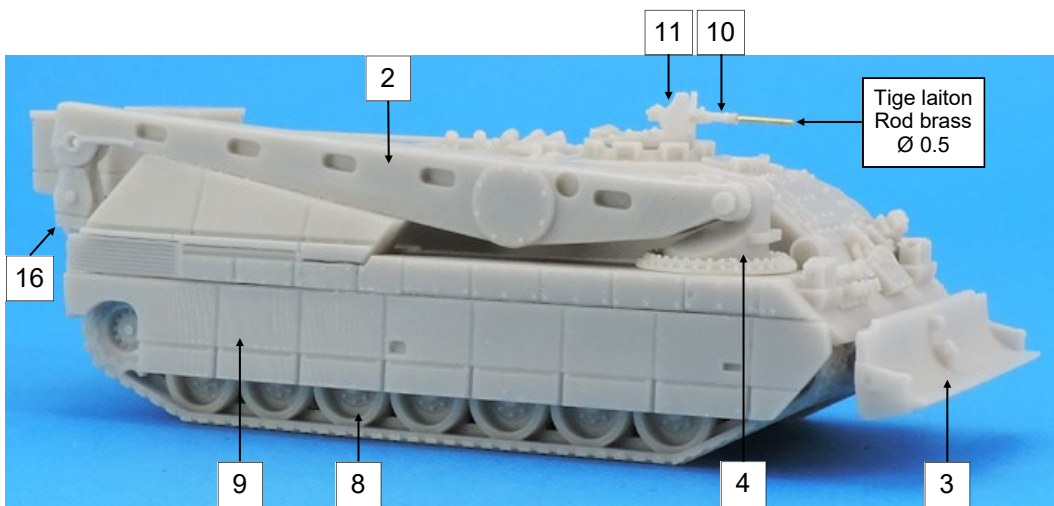
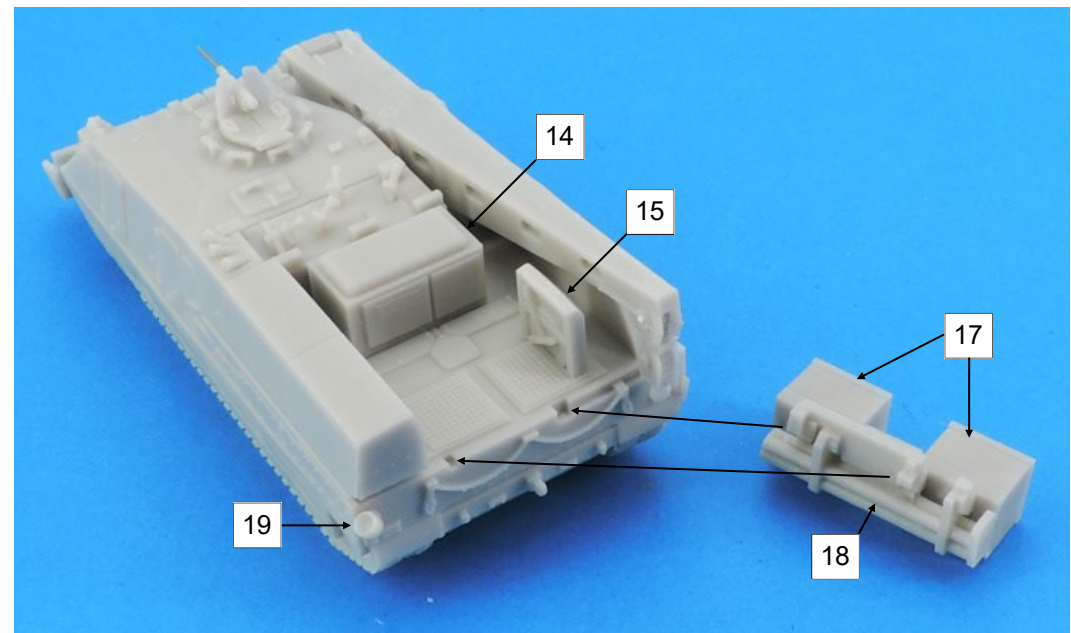
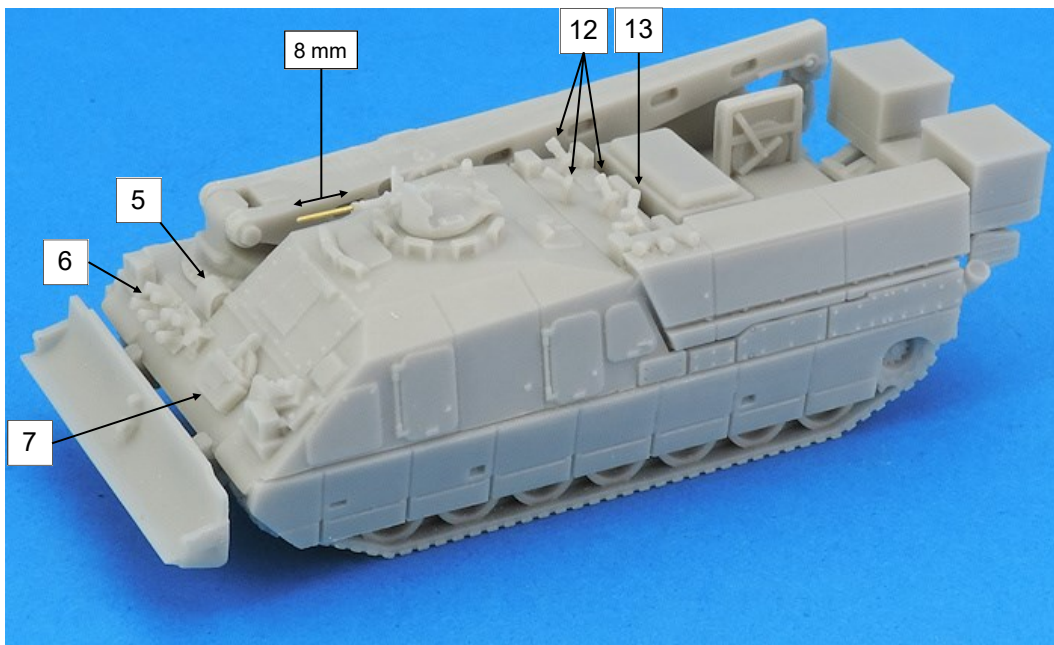

Aussi disponible monté et peint sur demande